

No part of this product may be reproduced in any form or by any electronic or mechanical means, including information storage and retrieval systems, without written permission from the IB.

Additionally, the license tied with this product prohibits commercial use of any selected files or extracts from this product. Use by third parties, including but not limited to publishers, private teachers, tutoring or study services, preparatory schools, vendors operating curriculum mapping services or teacher resource digital platforms and app developers, is not permitted and is subject to the IB's prior written consent via a license. More information on how to request a license can be obtained from <http://www.ibo.org/contact-the-ib/media-inquiries/for-publishers/guidance-for-third-party-publishers-and-providers/how-to-apply-for-a-license>.

Aucune partie de ce produit ne peut être reproduite sous quelque forme ni par quelque moyen que ce soit, électronique ou mécanique, y compris des systèmes de stockage et de récupération d'informations, sans l'autorisation écrite de l'IB.

De plus, la licence associée à ce produit interdit toute utilisation commerciale de tout fichier ou extrait sélectionné dans ce produit. L'utilisation par des tiers, y compris, sans toutefois s'y limiter, des éditeurs, des professeurs particuliers, des services de tutorat ou d'aide aux études, des établissements de préparation à l'enseignement supérieur, des fournisseurs de services de planification des programmes d'études, des gestionnaires de plateformes pédagogiques en ligne, et des développeurs d'applications, n'est pas autorisée et est soumise au consentement écrit préalable de l'IB par l'intermédiaire d'une licence. Pour plus d'informations sur la procédure à suivre pour demander une licence, rendez-vous à l'adresse <http://www.ibo.org/fr/contact-the-ib/media-inquiries/for-publishers/guidance-for-third-party-publishers-and-providers/how-to-apply-for-a-license>.

No se podrá reproducir ninguna parte de este producto de ninguna forma ni por ningún medio electrónico o mecánico, incluidos los sistemas de almacenamiento y recuperación de información, sin que medie la autorización escrita del IB.

Además, la licencia vinculada a este producto prohíbe el uso con fines comerciales de todo archivo o fragmento seleccionado de este producto. El uso por parte de terceros —lo que incluye, a título enunciativo, editoriales, profesores particulares, servicios de apoyo académico o ayuda para el estudio, colegios preparatorios, desarrolladores de aplicaciones y entidades que presten servicios de planificación curricular u ofrezcan recursos para docentes mediante plataformas digitales— no está permitido y estará sujeto al otorgamiento previo de una licencia escrita por parte del IB. En este enlace encontrará más información sobre cómo solicitar una licencia: <http://www.ibo.org/es/contact-the-ib/media-inquiries/for-publishers/guidance-for-third-party-publishers-and-providers/how-to-apply-for-a-license>.

Physics
Standard level
Paper 1

Friday 17 May 2019 (afternoon)

45 minutes

Instructions to candidates

- Do not open this examination paper until instructed to do so.
- Answer all the questions.
- For each question, choose the answer you consider to be the best and indicate your choice on the answer sheet provided.
- A clean copy of the **physics data booklet** is required for this paper.
- The maximum mark for this examination paper is **[30 marks]**.

1. A student measures the radius R of a circular plate to determine its area. The absolute uncertainty in R is ΔR .

What is the **fractional** uncertainty in the area of the plate?

- A. $\frac{2\Delta R}{R}$
- B. $\left(\frac{\Delta R}{R}\right)^2$
- C. $\frac{2\pi\Delta R}{R}$
- D. $\pi\left(\frac{\Delta R}{R}\right)^2$
2. What is the unit of electrical potential difference expressed in fundamental SI units?
- A. $\text{kgms}^{-1}\text{C}^{-1}$
- B. $\text{kgm}^2\text{s}^{-2}\text{C}^{-1}$
- C. $\text{kgm}^2\text{s}^{-3}\text{A}^{-1}$
- D. $\text{kgm}^2\text{s}^{-1}\text{A}$
3. The graph shows the variation of velocity of a body with time along a straight line.

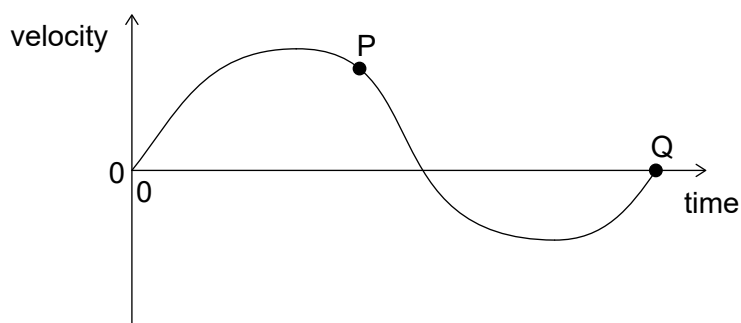

What is correct for this graph?

- A. The maximum acceleration is at P.
- B. The average acceleration of the body is given by the area enclosed by the graph and time axis.
- C. The maximum displacement is at Q.
- D. The total displacement of the body is given by the area enclosed by the graph and time axis.

4. Two forces of magnitude 12 N and 24 N act at the same point. Which force **cannot** be the resultant of these forces?
- A. 10 N
 B. 16 N
 C. 19 N
 D. 36 N
5. An object has a weight of 6.10×10^2 N. What is the change in gravitational potential energy of the object when it moves through 8.0 m vertically?
- A. 5 kJ
 B. 4.9 kJ
 C. 4.88 kJ
 D. 4.880 kJ
6. A boat with an output engine power of 15 kW moves through water at a speed of 10 ms^{-1} . What is the resistive force acting on the boat?
- A. 0.15 kN
 B. 0.75 kN
 C. 1.5 kN
 D. 150 kN
7. An astronaut is moving at a constant velocity in the absence of a gravitational field when he throws a tool away from him.

What is the effect of throwing the tool on the total kinetic energy of the astronaut and the tool and the total momentum of the astronaut and the tool?

	Total kinetic energy of the astronaut and tool	Total momentum of the astronaut and tool
A.	no change	increases
B.	no change	no change
C.	increases	increases
D.	increases	no change

Turn over

8. A table-tennis ball of mass 3g is fired with a speed of 10 m s^{-1} from a stationary toy gun of mass 0.600 kg. The gun and ball are an isolated system.

What are the recoil speed of the toy gun and the total momentum of the system immediately after the gun is fired?

	Recoil speed of the toy gun / m s^{-1}	Total momentum of the system / kg m s^{-1}
A.	0.05	0
B.	0.05	0.03
C.	0.5	0
D.	0.5	0.03

9. A block of weight W slides down a ramp at constant velocity. A friction force F acts between the bottom of the block and the surface of the ramp. A normal reaction N acts between the ramp and the block. What is the free-body diagram for the forces that act on the block?

A.

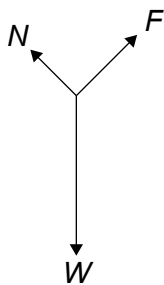

B.

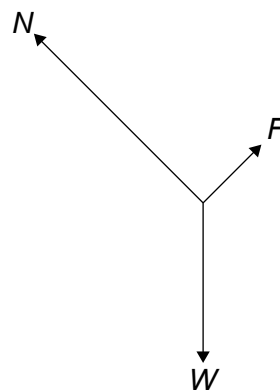

C.

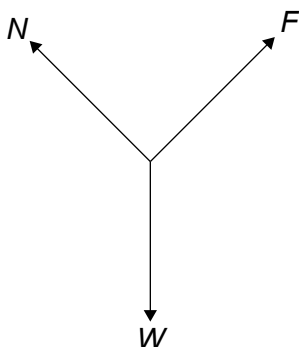

D.

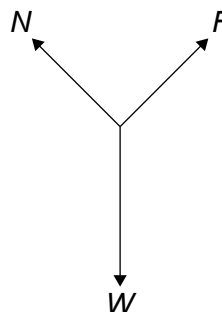

10. A substance changes from the solid phase to the gas phase without becoming a liquid and without a change in temperature.

What is true about the internal energy of the substance and the total intermolecular potential energy of the substance when this phase change occurs?

	Internal energy of the substance	Total intermolecular potential energy of the substance
A.	increases	no change
B.	no change	no change
C.	increases	increases
D.	no change	increases

11. The temperature of a fixed mass of an ideal gas changes from 200 °C to 400 °C.

What is $\frac{\text{mean kinetic energy of gas at } 200^\circ\text{C}}{\text{mean kinetic energy of gas at } 400^\circ\text{C}}$?

- A. 0.50
 B. 0.70
 C. 1.4
 D. 2.0
12. A container holds 20 g of argon-40 ($^{40}_{18}\text{Ar}$) and 40 g of neon-20 ($^{20}_{10}\text{Ne}$).

What is $\frac{\text{number of atoms of argon-40}}{\text{number of atoms of neon-20}}$ in the container?

- A. 0.25
 B. 0.5
 C. 2
 D. 4

Turn over

13. The graph shows the variation of the displacement of a wave with distance along the wave. The wave speed is 0.50 m s^{-1} .

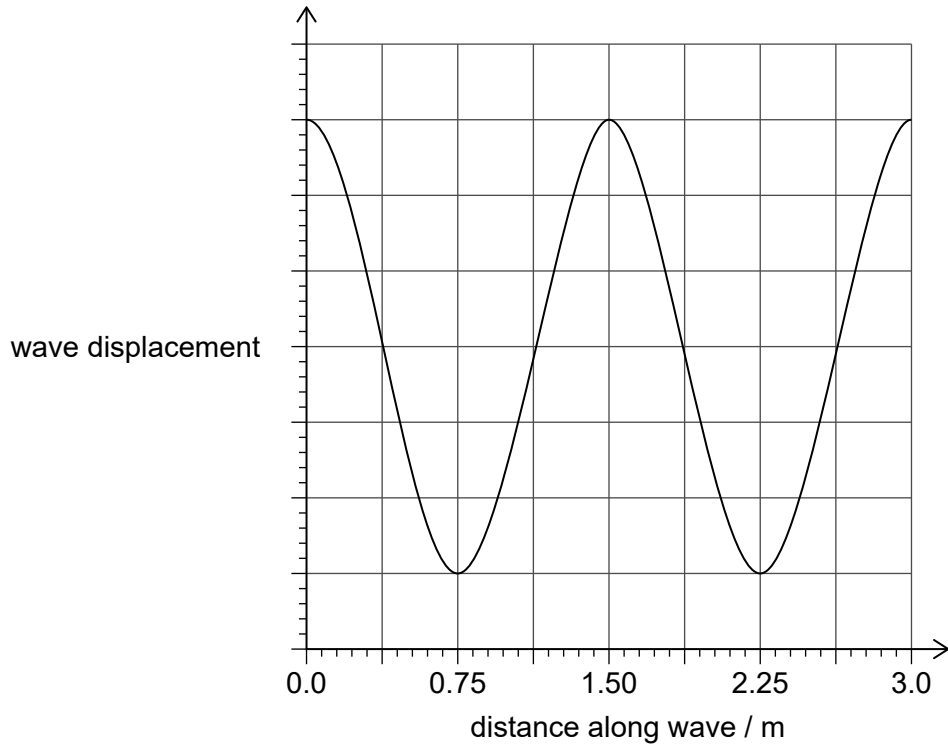

What is the period of the wave?

- A. 0.33 s
- B. 1.5 s
- C. 3.0 s
- D. 6.0 s

14. Object P moves vertically with simple harmonic motion (shm). Object Q moves in a vertical circle with a uniform speed. P and Q have the same time period T . When P is at the top of its motion, Q is at the bottom of its motion.

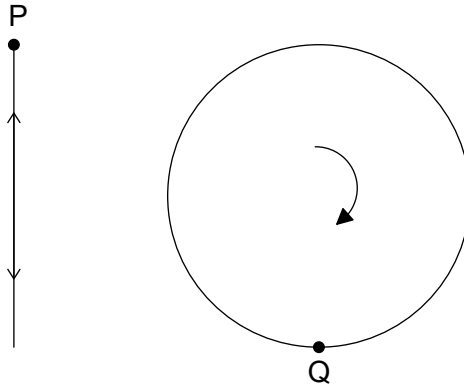

What is the interval between successive times when the acceleration of P is equal and opposite to the acceleration of Q?

- A. $\frac{T}{4}$
- B. $\frac{T}{2}$
- C. $\frac{3T}{4}$
- D. T

Turn over

15. Unpolarized light is incident on two polarizers. The axes of polarization of both polarizers are initially parallel. The second polarizer is then rotated through 360° as shown.

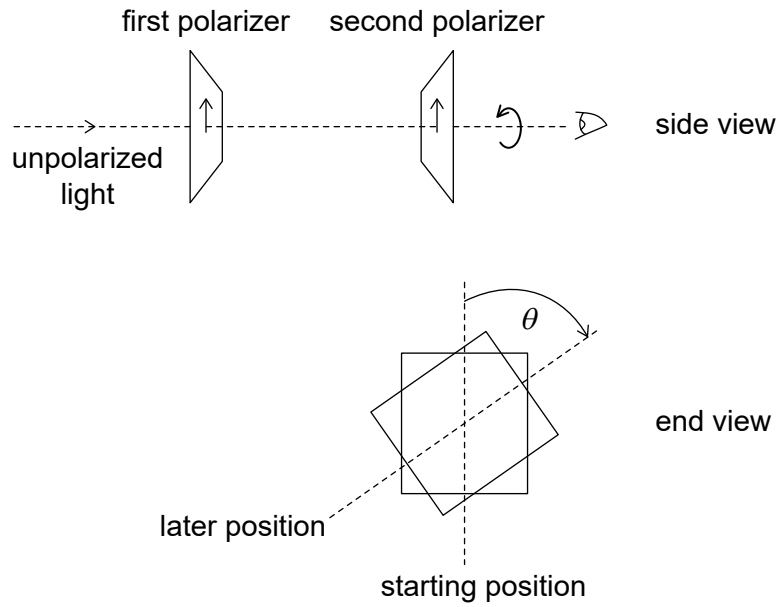

Which graph shows the variation of intensity with angle θ for the light leaving the second polarizer?

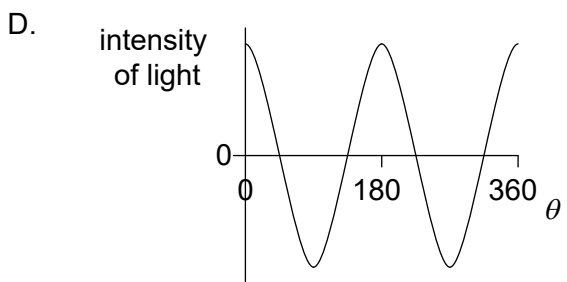
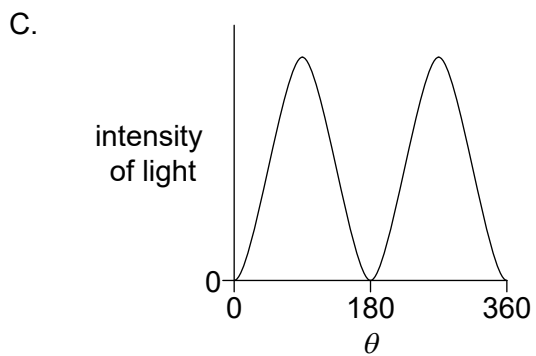
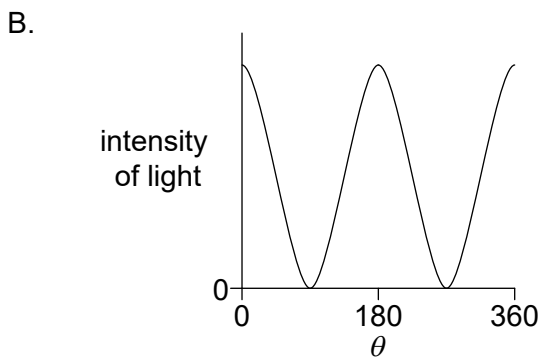
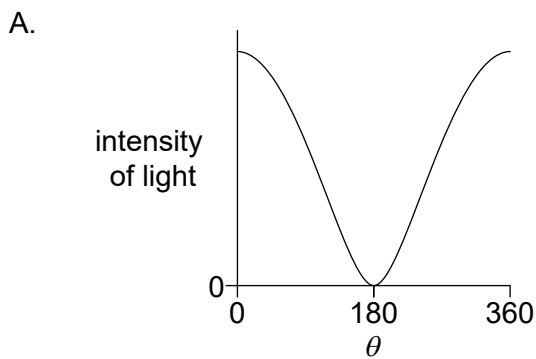

16. Monochromatic light travelling upwards in glass is incident on a boundary with air. The path of the refracted light is shown.

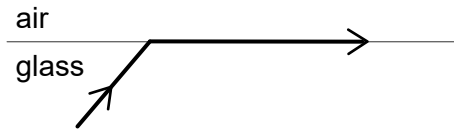

A layer of liquid is then placed on the glass without changing the angle of incidence on the glass. The refractive index of the glass is greater than the refractive index of the liquid and the refractive index of the liquid is greater than that of air.

What is the path of the refracted light when the liquid is placed on the glass?

A.

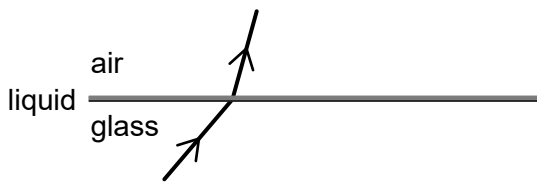

B.

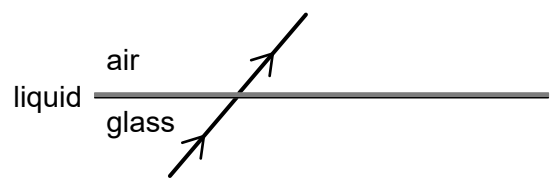

C.

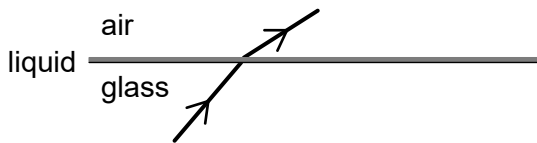

D.

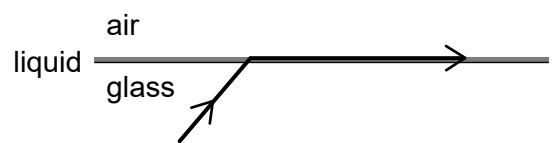

Turn over

17. A student blows across the top of a cylinder that contains water. A first-harmonic standing sound wave is produced in the air of the cylinder. More water is then added to the cylinder. The student blows so that a first-harmonic standing wave is produced with a different frequency.

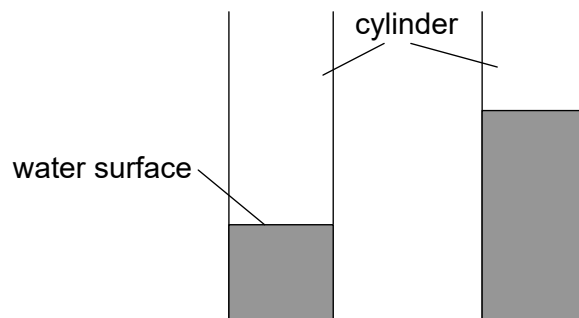

What is the nature of the displacement in the air at the water surface and the change in frequency when the water is added?

	Nature of displacement	Change in frequency
A.	antinode	decrease
B.	antinode	increase
C.	node	decrease
D.	node	increase

18. A particle with a charge ne is accelerated through a potential difference V .

What is the magnitude of the work done on the particle?

- A. eV
 B. neV
 C. $\frac{nV}{e}$
 D. $\frac{eV}{n}$

19. The resistance of component X decreases when the intensity of light incident on it increases. X is connected in series with a cell of negligible internal resistance and a resistor of fixed resistance. The ammeter and voltmeter are ideal.

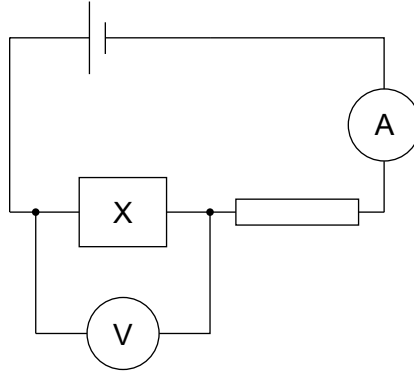

What is the change in the reading on the ammeter and the change in the reading on the voltmeter when the light incident on X is increased?

	Ammeter reading	Voltmeter reading
A.	increases	decreases
B.	increases	increases
C.	decreases	decreases
D.	decreases	increases

20. Three resistors of resistance $1.0\ \Omega$, $6.0\ \Omega$ and $6.0\ \Omega$ are connected as shown. The voltmeter is ideal and the cell has an emf of 12V with negligible internal resistance.

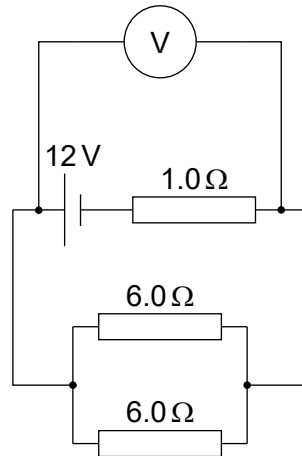

What is the reading on the voltmeter?

- A. 3.0V
 - B. 4.0V
 - C. 8.0V
 - D. 9.0V
21. A horizontal wire PQ lies perpendicular to a uniform horizontal magnetic field.

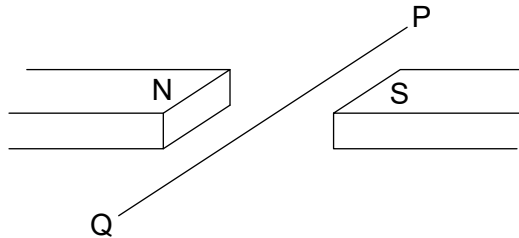

A length of 0.25m of the wire is subject to a magnetic field strength of 40mT . A downward magnetic force of 60mN acts on the wire.

What is the magnitude and direction of the current in the wire?

	Current magnitude / A	Current direction
A.	6.0	P to Q
B.	6.0	Q to P
C.	0.17	Q to P
D.	0.17	P to Q

22. A particle of mass 0.02 kg moves in a horizontal circle of diameter 1 m with an angular velocity of $3\pi \text{ rad s}^{-1}$.

What is the magnitude and direction of the force responsible for this motion?

	Magnitude of force / N	Direction of force
A.	0.03π	away from centre of circle
B.	0.03π	towards centre of circle
C.	$0.09\pi^2$	away from centre of circle
D.	$0.09\pi^2$	towards centre of circle

23. Which graph shows the relationship between gravitational force F between two point masses and their separation r ?

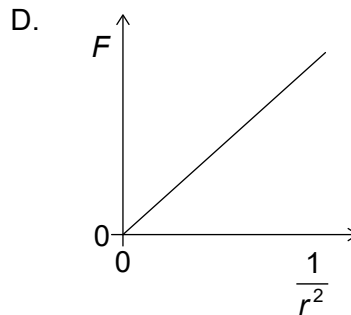
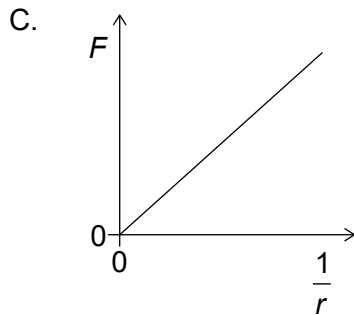
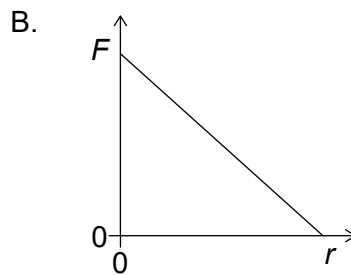
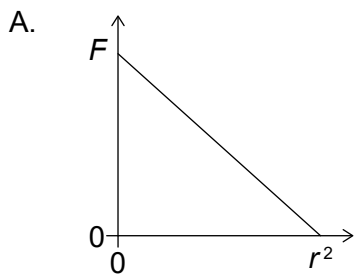

Turn over

24. A radioactive nuclide with atomic number Z undergoes a process of beta-plus (β^+) decay. What is the atomic number for the nuclide produced and what is another particle emitted during the decay?

	Atomic number	Particle
A.	$Z - 1$	neutrino
B.	$Z + 1$	neutrino
C.	$Z - 1$	anti-neutrino
D.	$Z + 1$	anti-neutrino

25. The positions of stable nuclei are plotted by neutron number n and proton number p . The graph indicates a dotted line for which $n = p$. Which graph shows the line of stable nuclides and the shaded region where unstable nuclei emit beta minus (β^-) particles?

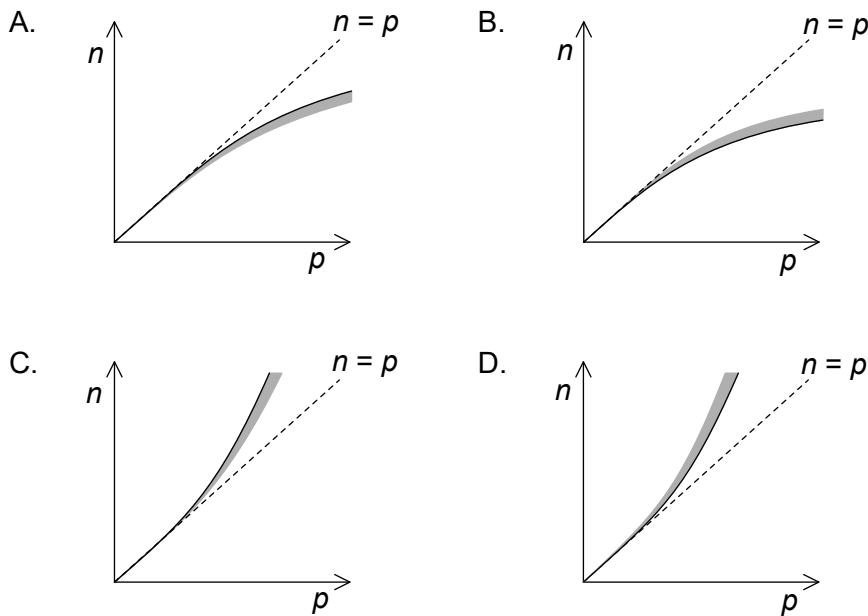

26. Three conservation laws in nuclear reactions are

- I. conservation of charge
- II. conservation of baryon number
- III. conservation of lepton number.

The reaction

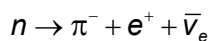

is proposed.

Which conservation laws are violated in the proposed reaction?

- A. I and II only
- B. I and III only
- C. II and III only
- D. I, II and III

27. Which Feynman diagram shows the emission of a photon by a charged antiparticle?

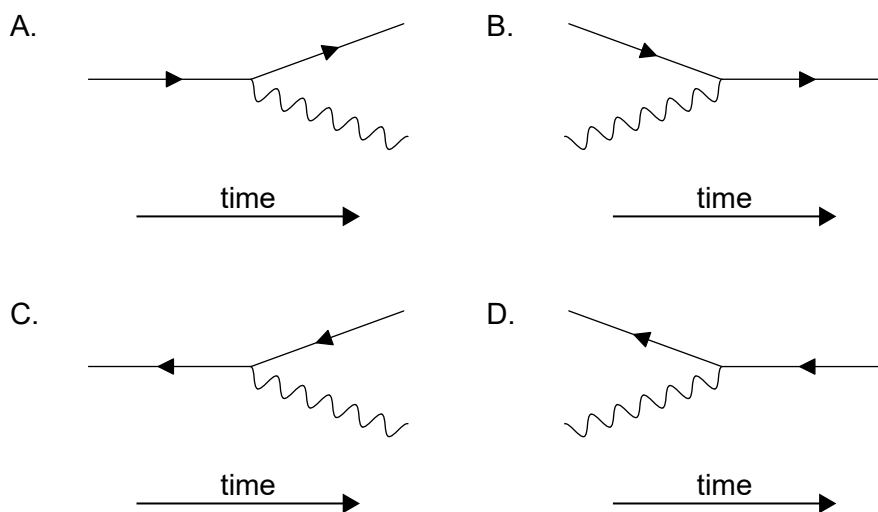

Turn over

28. A neutron collides head-on with a stationary atom in the moderator of a nuclear power station. The kinetic energy of the neutron changes as a result. There is also a change in the probability that this neutron can cause nuclear fission.

What are these changes?

	Change in kinetic energy of the neutron	Change in probability of causing nuclear fission
A.	increase	increase
B.	decrease	increase
C.	increase	decrease
D.	decrease	decrease

29. Three methods for the production of electrical energy are

- I. wind turbine
- II. photovoltaic cell
- III. fossil fuel power station.

Which methods involve the use of a primary energy source?

- A. I and II only
 - B. I and III only
 - C. II and III only
 - D. I, II and III
30. The orbital radius of the Earth around the Sun is 1.5 times that of Venus. What is the intensity of solar radiation at the orbital radius of Venus?
- A. 0.6 kW m^{-2}
 - B. 0.9 kW m^{-2}
 - C. 2 kW m^{-2}
 - D. 3 kW m^{-2}